











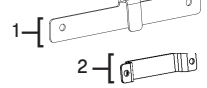



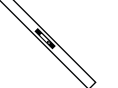
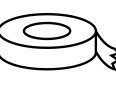

# MIRROR

## Stand Installation Template: STUD

See reverse for template to be used with masonry/drywall.

Included Pieces:				With Mirror:		Necessary Tools:				
										
<b>2 Anchors</b> AF5 ALLIGATOR®	<b>2 SMS Screws</b> Phillips #8 x 1-1/2"	<b>Anchors</b> 1 - Mirror, 2 - Wall	<b>Stand</b>	<b>1' Power Cord</b> C13 UL	<b>6' Power Cord</b> C13 UL	<b>Stud Finder</b>	<b>Pencil</b>	<b>Tape Measure</b>	<b>Level</b>	<b>Painter's Tape</b>
										
<b>4 M6x16 Screws</b> Flat Head	<b>6 Bumpers</b> Domed, 3/8" OD	<b>2 M6x12 Screws</b> Pan Head		<b>Care Kit</b> Spray, Shabby, Lens Cap		<b>Drill</b>	<b>Drill Bit</b> 1/8"	<b>Screwdriver</b> Phillips	<b>Blanket</b>	

**1** **Locate stud.** Select a location for the Mirror within 6' of an outlet. Using the **stud finder**, find one stud to which you want to attach the wall mount. Mark the left & right side of it with **pencil**, then determine the stud's center & mark vertically.

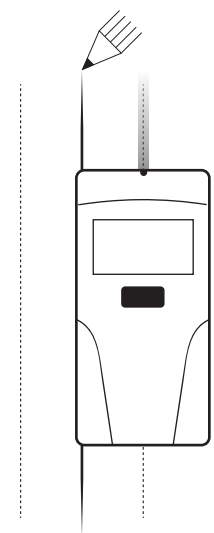

**2** **Hang template.** Use table to determine how high to hang, **measure** up from floor, and mark wall with **pencil**. If there are 2+ users, use the average of their heights. Align square at bottom of template with mark, check alignment with **level**, then **tape** firmly in place.

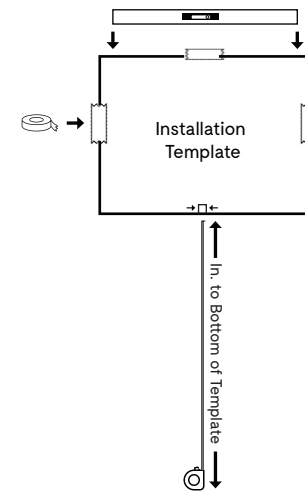

User Height	Floor to Bottom of Template	Distance D
5'0"-5'5"	54 7/8"	5"
5'6"-5'11"	54 6/8"	6"
6'0"-6'5"	54 5/8"	7"

**3** **Drill pilot holes.** Position the lid of shipper box under the template to catch drilling debris. Use **drill** and **1/8" drill bit** to make 1.5" deep holes in circles 1 and 2 on the template below. If an error renders a hole unusable, move the template horizontally and start over.

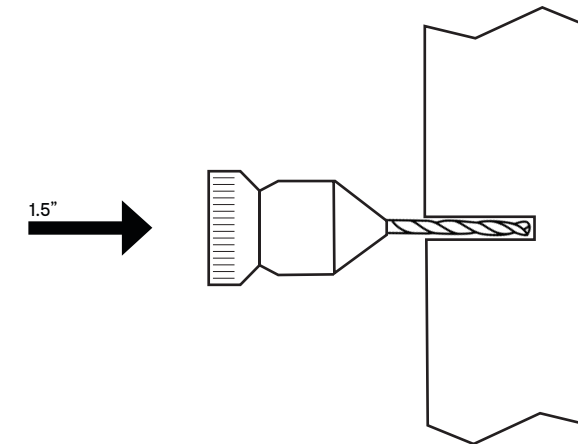

**4** **Place the wall anchor.** Place the wall anchor over pilot holes 1-2, then insert **mounting screws** into the holes. Tighten screws halfway with the **Phillips screwdriver**.

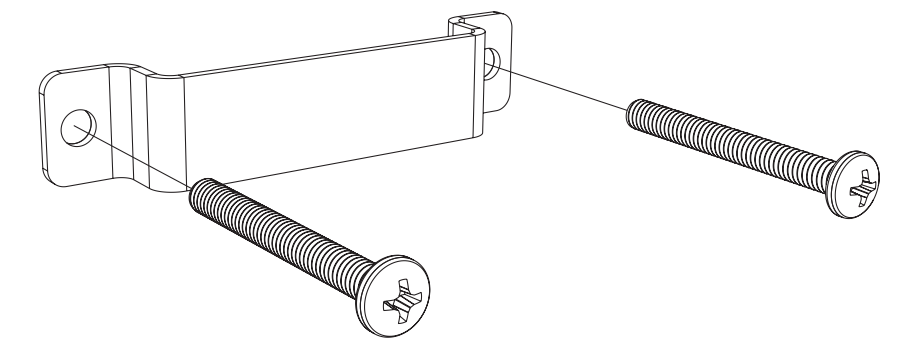

**5** **Secure the wall anchor.** Use the **level** to ensure the anchor is straight, then tighten the screws completely with the **Phillips screwdriver**.

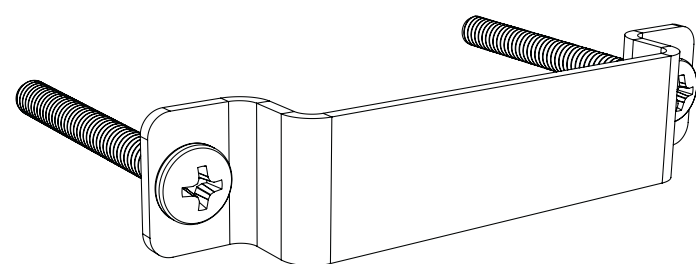

**6** **Prepare the Mirror.** Gently place the Mirror facedown on **blanket**. Attach **stand** as shown using **Phillips screwdriver** and **M6x16 flat head screws**. Attach **Mirror anchor** using **M6x12 pan head screws**. Install **bumpers** using adhesive backing along back edge of the Mirror as shown.

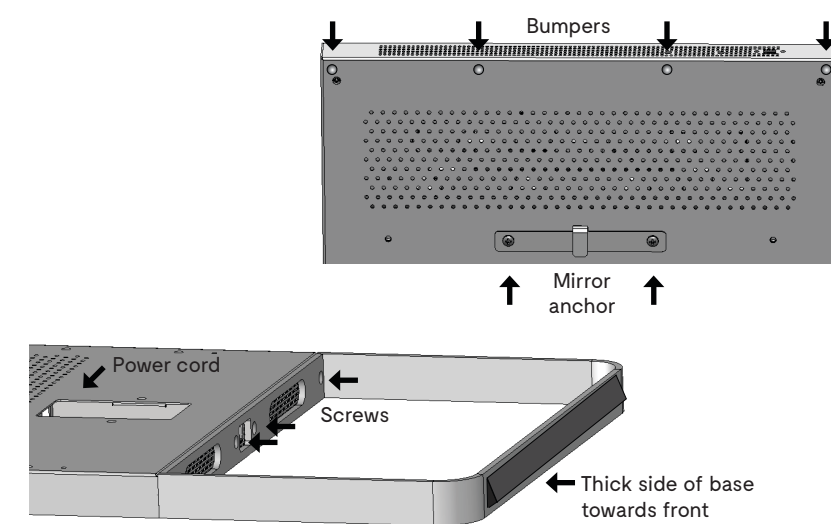

**7** **Insert power cord and hang the Mirror.** Select the shortest possible **power cord** given the Mirror's distance from outlet. Insert the power cord into the Mirror and hide any excess cable length. Lift the **Mirror anchor** over the **wall anchor** (a). Adjust horizontal orientation as necessary for appearance and ensure the placement is secure. Plug power cord into an outlet. Pull the Mirror out from the wall the number of inches specified under Distance D (b) in Step 2.

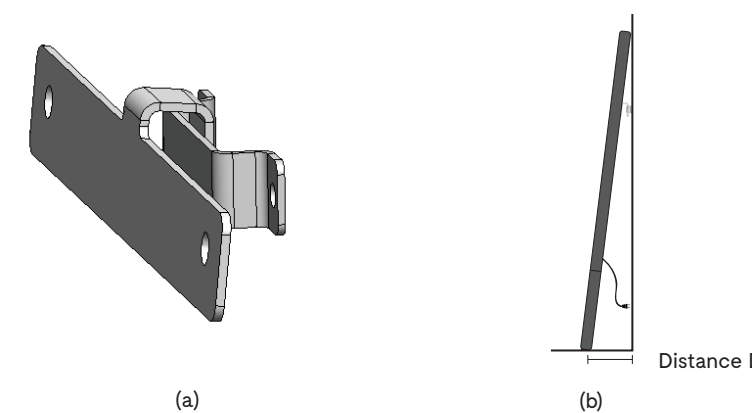

**8** **Clean and test.** Only clean Mirror with provided tools. Spray the Mirror 3 times with **cleaning spray** (a), wipe with **shabby**, and return both to **Care Kit**. Clear drilling debris. Turn the Mirror on using switch on bottom and check for set up screen (b). Do not turn off. Take with you all packaging besides the Care Kit.

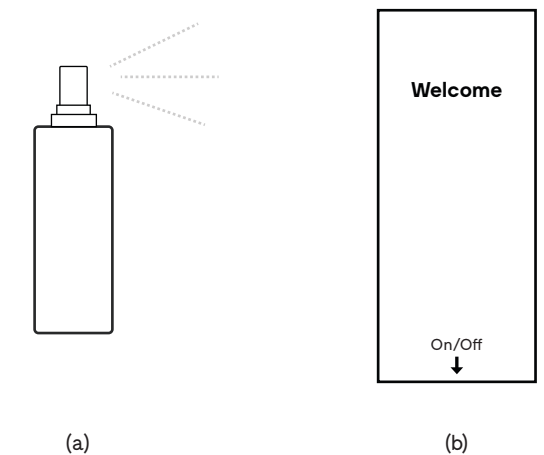

USE THESE INSTRUCTIONS EXACTLY AS WRITTEN.

If you do not install the Mirror according to these exact instructions, the Mirror warranty will be voided and you assume all liability for product use. To view the Mirror warranty, visit [MIRROR.CO/WELCOME](http://MIRROR.CO/WELCOME). To request a physical copy, call the number below. Any changes or modifications not expressly approved by Curiouser Products Inc. could void your authorization to operate this device.

Get in touch with MIRROR:  
P: 888-445-3653  
E: [hello@mirror.co](mailto:hello@mirror.co)